

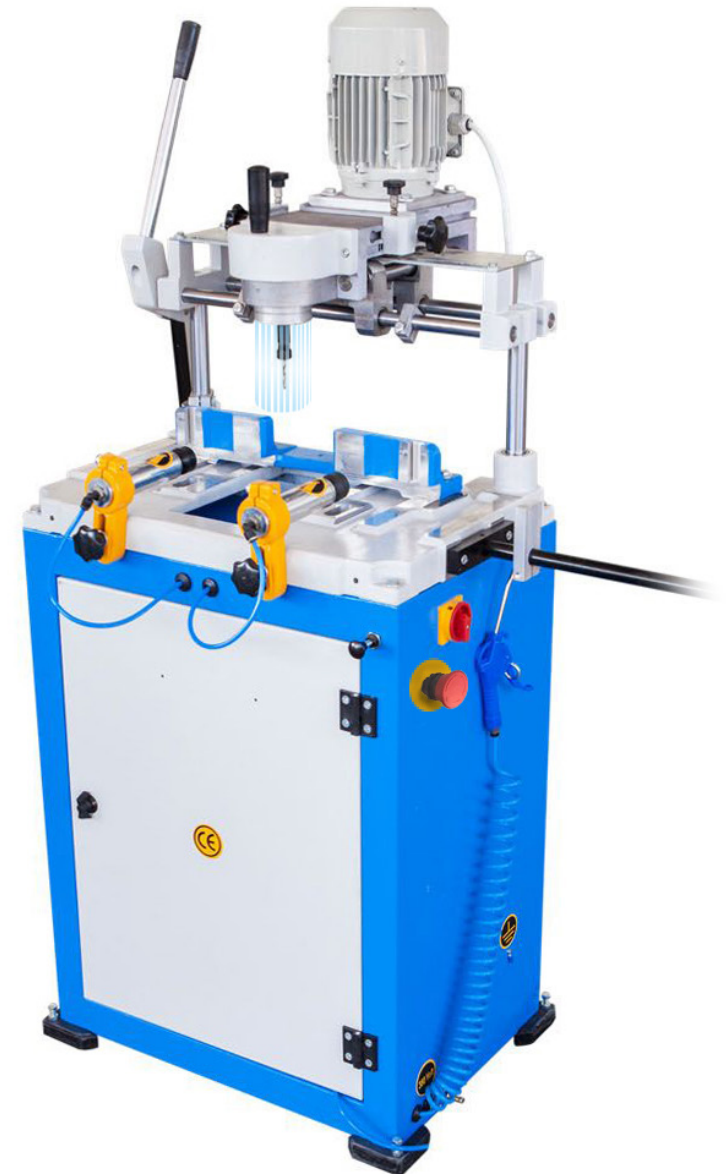

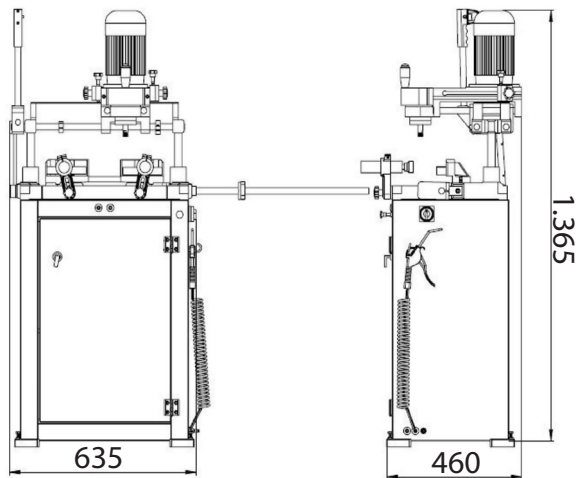



AZOR-I

Fresadora / Copiadora - REF : MF60

CARACTERÍSTICAS

- » Con los pies ajustables de la máquina, el nivel de la base se regula fácilmente.
- » Aperturas de perforación bajo la manilla y cerradura realizadas a mano.
- » Para la creación de agujeros en perfiles de aluminio y PVC.
- » La sujeción del perfil se realiza mediante una válvula.
- » Cuchilla regulada en altura, profundidad y ángulo.
- » Diseñada acorde con las normas de la CE.
- » Máxima fiabilidad de funcionamiento.

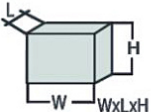

Características técnicas						
			BAR	Hava tüke. Air cons.		
	1,1 KW 400V 50Hz	11000 D/dak. RPM	5-9 Bar	5 Lt/dak. Lt/min.	56x70x140 cm	77 kg