

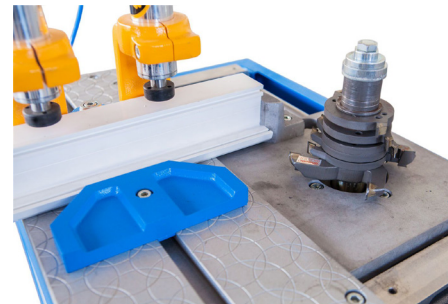

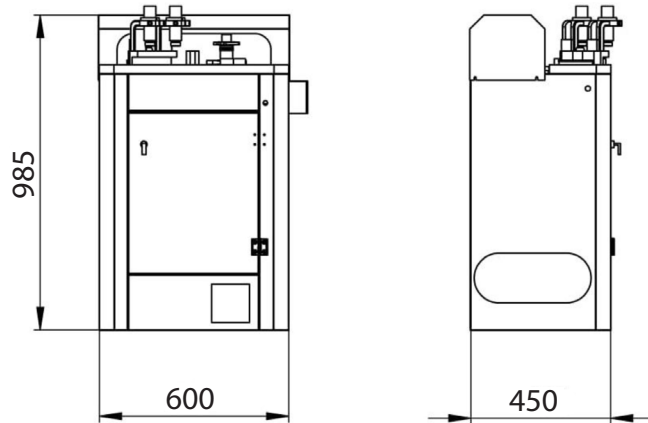





# PUMA-I

Retestadora automática simple fresa - REF : MR600AS

## CARACTERÍSTICAS

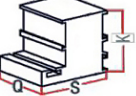
- » Para perfiles de aluminio y PVC.
- » Tiempo de procesamiento de perfiles por los dos lados de 20 segundos.
- » Sistema de proceso para dos perfiles diferentes.
- » Velocidad regulada neumáticamente.
- » Diseñada en conformidad con la CE.
- » Máquina de uso automático.

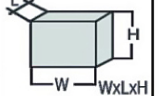

Características técnicas								
					BAR	Hava tüke. Air cons.		
	1.1 KW 400V 50Hz	D=150mm(max) d=30 mm	3000 D/dak. RPM	K=80mm(max) S=75mm(max) Q=.....	6-8 Bar	5 Lt/dak. Lt/min.	81x55x120 cm	95 kg