

SKY-2000







Estación de montaje de herrajes de PVC - REF : M00159

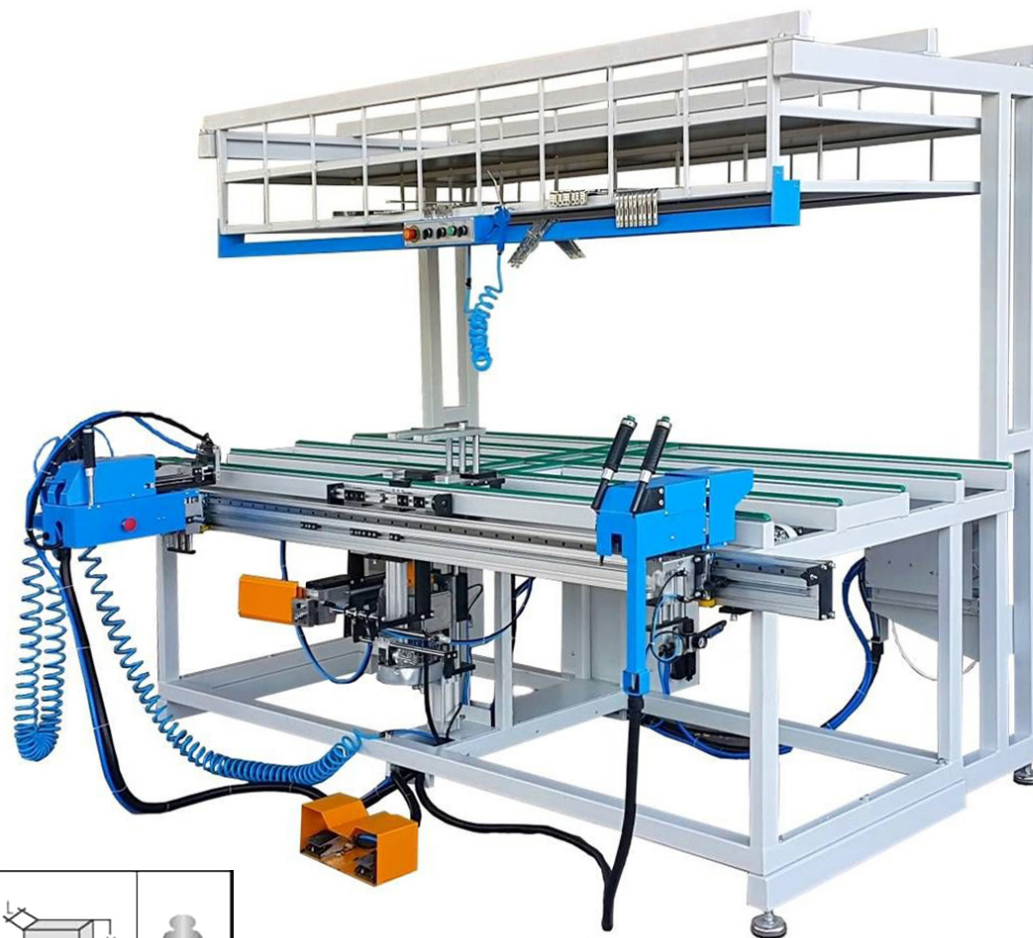
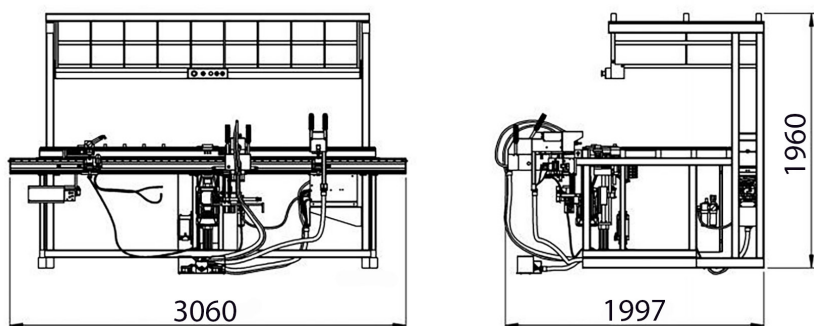

CARACTERÍSTICAS

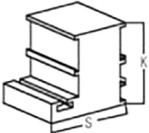
- » Facilidad de montaje de herrajes de marcos de PVC.
- » Estantes superiores e inferiores para piezas.
- » Corta piezas de doble apertura con las medidas solicitadas y atornilla en el marco.
- » Se pueden montar cremoneras de apertura única en los marcos de las puertas.
- » Perforación triple (cremonera) en marcos de guillotina.
- » Taladra los agujeros de las bisagras y los pasadores en los marcos derecho e izquierdo.

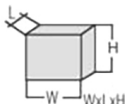

TECHNICAL FEATURES								
					BAR	Hava tüke. Air cons.		
SM-2200	1.1 KW 400V 50Hz	D= 7.5 - 8mm d= 3.9 - 4.2mm h= 15 - 25mm	S= 40mm (min) K=40mm (min)	a _{min} = 400mm a _{max} = 2200mm b _{min} = 400mm b _{max} = 2200mm	6-8 Bar	60 Lt/dak. Lt/min.	W= 3100mm L= 2000mm H= 2150mm	561 kg