

TASMANIA-I







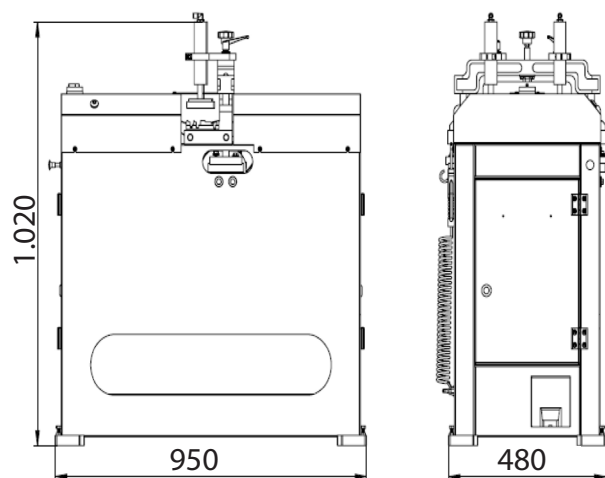

Junquilladora corte automático 2 discos - REF : MCJ2D

CARACTERÍSTICAS

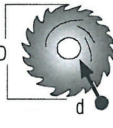
- » Corte automático de junquillos hechos de aluminio o PVC.
- » Protección contra operaciones accidentales.
- » Diseñada en conformidad con la CE.
- » Controlada por electro-neumática.
- » Ambos finales son cortados a la vez.
- » Sistemas de medidas estándar.
- » Ángulo de corte de 45°.
- » Ajuste de la velocidad.
- » 2 discos de sierra.
- » Altura ajustable.

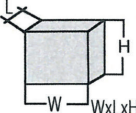

Características técnicas								
					BAR	Air cons.		
	0,05 KW x 2 400V 50Hz	D=200 mm d=32 mm	D=115 mm d=22 mm	3000 RPM	6-8 Bar	35 Lt/min.	98x 53 x125 cm	102 kg

